

KATA VIDEO LINE 2007



ENGLISH EDITION



KATA

Protective Carrying Solutions
www.kata-bags.com

PRO VIDEO COLLECTION

Designed specifically and ergonomically around the user, The Pro Video collection provides you with the perfect balance of light weight and protection.

Crafted and Perfected over a decade working with leading industry professionals, the Pro Video collection provides some of the best ergonomic comprehensive working solutions available today. State-of-the-art protective carrying and working solutions for Pro HD, ENG, EFP, HDV, DV & Mini-DV.

- Camcorder bags and backpacks
- Camera Gloves and DV/HDV Guards
- Rain Covers
- Audio Solutions
- Monitor and Editing bags
- Lighting cases and more...

Kata's extensive test team keeps in tune with industry professionals around the world to research and identify the needs of today's modern photography industry. To meet these demands, we design, develop and update our products to meet the latest technology and user requirements.



CARRYING & WORKING SOLUTIONS

PROTECTION & LIGHTWEIGHT PERFECTLY BALANCED

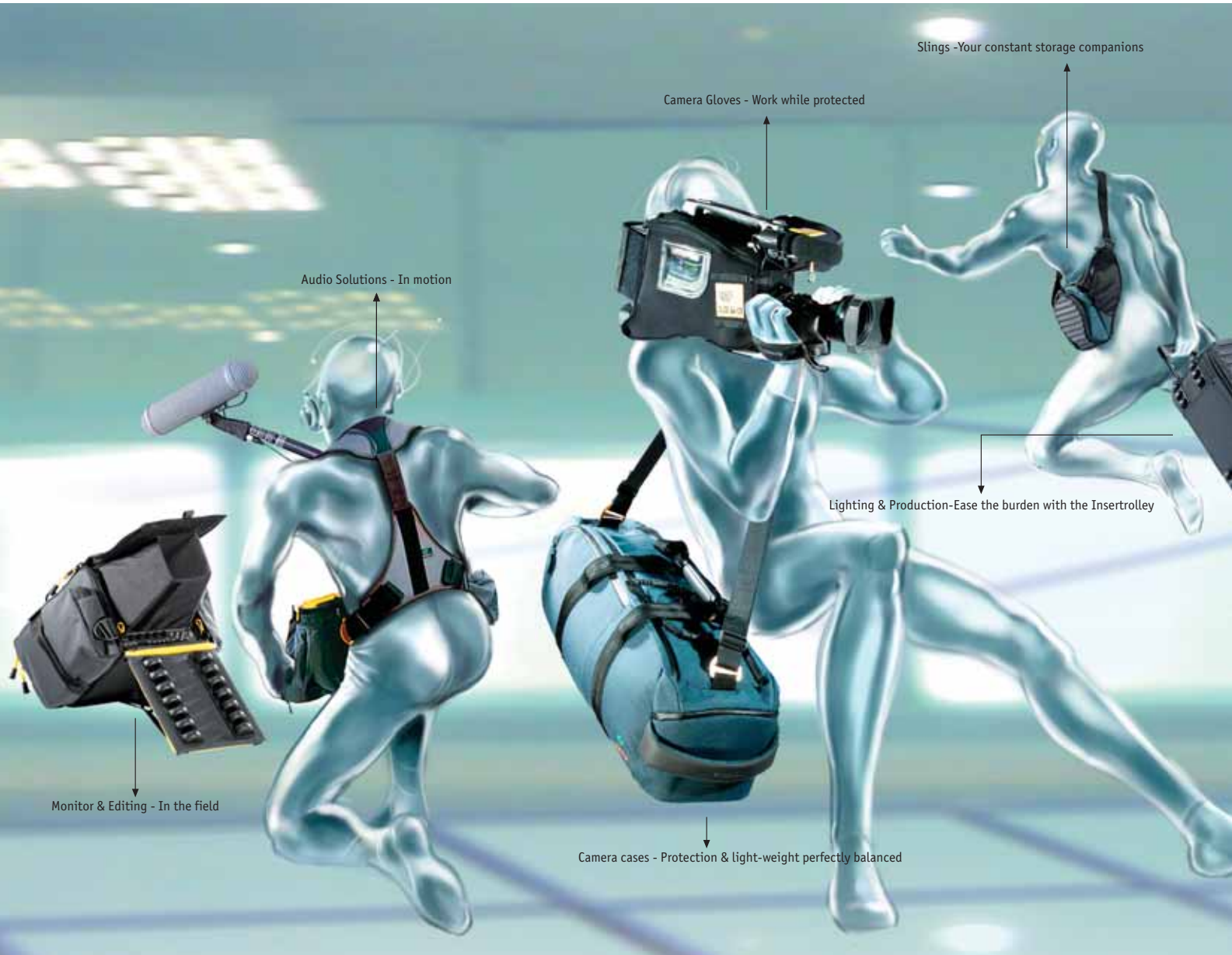

'Click' Interlocking Handles



Our patented CLICK handles have been designed and field-tested for sure grip and optimal comfort. The unique engineering and shape of the thermo-rubber pads ergonomically fit your hand. Just 'click' the two parts together and you are ready to go!



Shoulder Straps



①
NEW

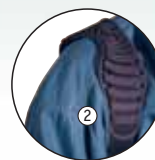

②



③



④



⑤

- 1) APSS Advanced Padded Shoulder Strap (Patented), page 52
- 2) NSS Non-Slip Shoulder Strap (Patented), page 52
- 3) BSS "B" shaped shoulder strap
- 4) SPAD Thermoplastic padded shoulder strap
- 5) STRP Adjustable shoulder strap

PROTECTING SOLUTIONS >>

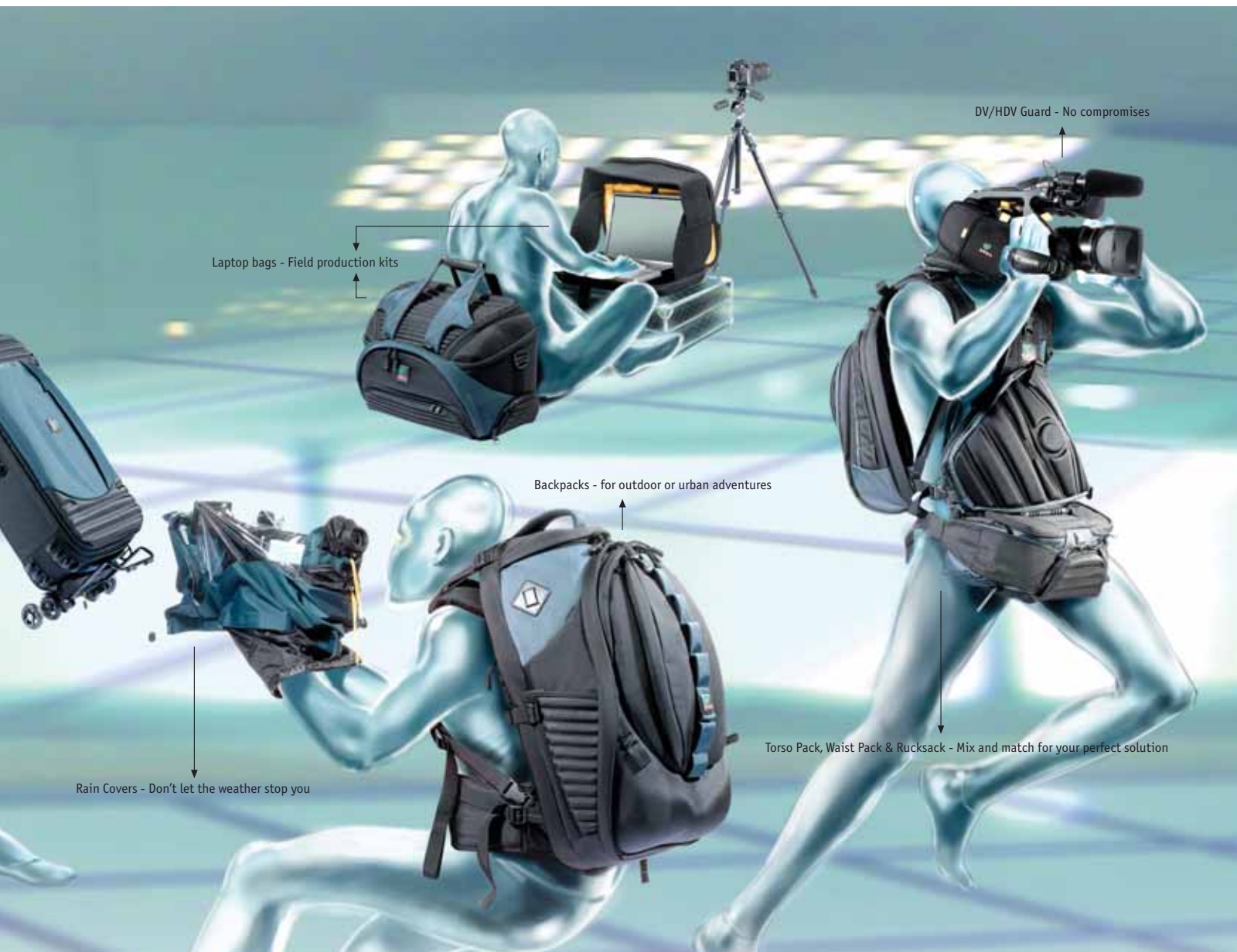

Laptop bags - Field production kits

DV/HDV Guard - No compromises

Backpacks - for outdoor or urban adventures

Torso Pack, Waist Pack & Rucksack - Mix and match for your perfect solution

Rain Covers - Don't let the weather stop you

DPB



Shoulder straps attach to the bag via this rugged yet light weight buckle, which accepts either a quick-release hook or the strap itself. Either option ensures that the strap will cross the shoulder at the optimal ergonomic angle to provide excellent comfort and stability.

Insertrolley



Revolutionary Modular Trolley System with extendable wheels to better stabilize large cases (Patent Pend), page 52.

EPH



The Ergonomic Photo System is a modular system that allows you to attach 1-3 KATA cases together, page 26.

PROTECTING SOLUTIONS

PROTECTION & LIGHT-WEIGHT PERFECTLY BALANCED

Our mission is to provide the maximum protection with the most ergonomic, lightweight design possible. We want our products to work with you and help you do your job in the best possible way.



TST

TST - Thermo-Shield-Technology provides state-of-the-art protection for digital equipment while creating an extremely light product.

1. Thermo-formed "rib-shape" construction (Patent Pend.)
2. Mil-Std water, dust and abrasion resistant Super Nylon®.
3. Shock protective insulated Cross-linked, closed cell PE+EVA shield.
4. Vibration reducing Air-PU for internal padding and cushioning.
5. Anti-scratch Yelloop® lining enables divider attachment, and location of small objects in poor lighting conditions.

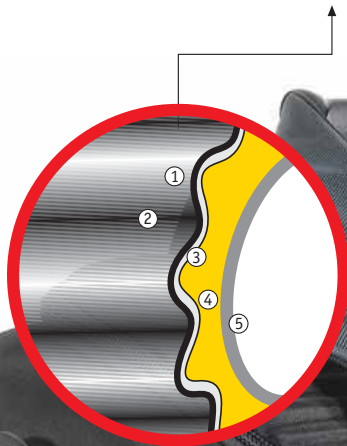

Six Layers of Protection



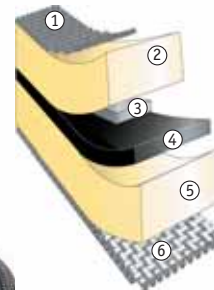

















We surround your equipment with the most protection possible, while still maintaining a lightweight design.



1. Polyester 600D
2. High-Density Polyethylene Foam
3. Aluminum Stave
4. Polypropylene Panel
5. Soft Polyurethane Foam
6. Cordura® 1000



Icon Index

-  **TOBLERONE**
See Page 7
-  **ELEMENTS COVER**
See Page 7
-  **THERMO SHIELD TECHNOLOGY**
See Page 6
-  **MEDIA KIT**
-  **ON BOARD**
See Page 11
-  **TAIL TRAP BUCKLE**
See Page 47
-  **LAPTOP COMPARTMENT**
-  **CLICK HANDLES**
See Page 4
-  **DP BUCKLE**
See Page 4
-  **TRIPOD HOLDER**
See Page 21
-  **CAMERA STRAPS**
See Page 21
-  **SHOULDER STRAP-TYPE**
See Page 4
-  **OMEGA**
See Page 21
-  **INSERTROLLEY INCLUDED**
See Page 5
-  **INSERTROLLEY COMPATIBLE**
See Page 5
-  **MODI-VERS INCLUDED**
See Page 7
-  **MODI-VERS COMPATIBLE**
See Page 52
-  **FILTER SLEEVE COMPATIBLE**
See Page 52
-  **EPH SYSTEM COMPATIBLE**
See Page 26
-  **GDC COLLECTION**



Toblerone

Made from synthetic thermo-rubber, this uniquely designed feature absorbs shocks and protects the case from abrasion, dirt, mud and standing water.



Modi-Vers System

Kata products feature 'Yelloop' Hook & Loop interiors with included dividers or Modi-Vers strips that allow you to create compartments inside the cases to meet your exact set up and protection requirements. You can easily cut and configure the size and shape of the dividers. No glue, knives or special skills needed.

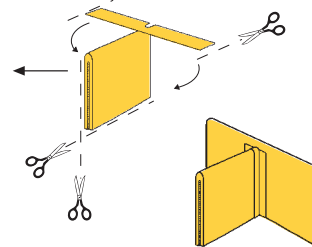

Element Protection

Camera Gloves, Guards and Rain Covers

KATA's Camera Gloves, DV/HDV Guards and Rain Covers provide you with every day protection of your gear no matter what climate or working conditions you may find yourself in.



KATA gloves are made of a specially engineered lamination:

1. External layer of nylon elastic knit, non-abrasive to your skin.
2. Middle layer of shock resistant, advanced closed cell foam prevents overheating of your camera.
3. Internal knit layer protects the camera body.

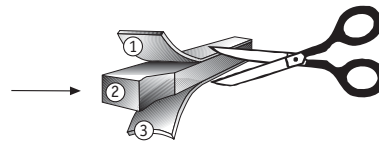

This non-fray lamination enables you to cut additional slots to fit your exact working configuration.



Reversible Elements Cover

An emergency reversible Elements Cover is included in many of our products to protect your case and equipment in inclement weather: black side out in rain or snow, and in sun reverse to silver for heat reflection.



MATCH YOUR BROADCAST CAMCORDER

TO A KATA SOLUTION!



CCC-1A
See page 10



GRIZZLY-3
See page 22



TCCT
See page 11



CC-HD-3
See page 11



MCC-2A
See page 10



*Camcorders shown are only examples of the type and size of camcorder that fits with products



RC-HD-3
See page 36



RC-OB
See page 35



CAMERA GLOVE
See pages 30-31



RC-1
See page 36

MATCH YOUR HDV CAMCORDERS

TO A KATA SOLUTION!



CC-195
See pages 14-15



CC-10A
See page 10



DVG-53
See pages 32-33



RC-11
See page 36



DVG-54
See pages 32-33



*Camcorders shown are only examples of the type and size of camcorder that fits with products



RC-10
See page 37



BP-502
See page 23

Our on-line bag chooser will accurately match any camcorder model - see back cover for details

MATCH YOUR HDV/DU CAMCORDERS

TO A KATA SOLUTION!



MC-61
See page 13



CC-193/195
See page 14-15



HB-207
See page 24



*Camcorders shown are only examples of the type and size of camcorder that fits with products



RC-15
See page 37



HB-102/103
See page 25



RC-14
See page 37



WS-604/605
See page 16



DVG-52
See pages 32-33



DVG-51
See pages 32-33

MATCH YOUR MINI-HDV/DU CAMCORDERS

TO A KATA SOLUTION!



CC-190/191
See pages 14-15



CRC-13
See page 37



CRC-18
See page 37



R-101/102/103
See page 25



*Camcorders shown are only examples of the type and size of camcorder that fits with products



PB-44/46/48
See page 17



C-58/59
See page 18



W-92/94
See pages 26



T-212/214
See page 27

Our on-line bag chooser will accurately match any camcorder model - see back cover for details